



**Model RD3  
ROLLER DOOR OPERATOR**



**Installation Instructions  
and  
Owner's Manual**

**READ THIS MANUAL CAREFULLY BEFORE BEGINNING INSTALLATION**

**Installer: Permanently attach manual to the wall.**

# Inventory



**Operator Unit**

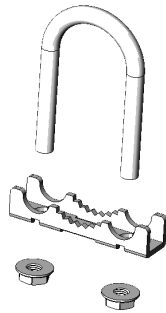

**U-bolt + Saddle x1 set**

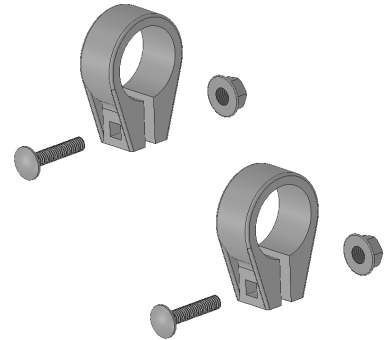

**Anti-Coning Clip x2 sets**



**Remote Handset x2 \***



**Wireless Wall Button x1 \***

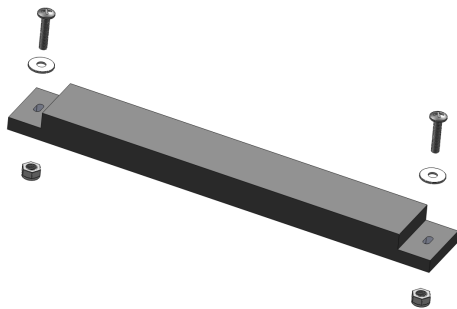

**Weight Bar & mounting screw set x1**

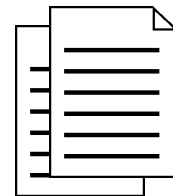

**Manual + Safety Label**

\* Optional Accessories

\* Items and quantity may differ to images shown

## SPECIFICATION

### Electrical Rating

Input	AC 220V 50/60Hz
Max. Current	2A
Power	100W
Standby Power	<2W

### Motor

Type	DC 24V
Max. Capacity	1000N

### Recommended Lifting Forces

Max. Lifting Force	60kg
Rated Lifting Force	40kg

### Door Type

Max. Door Size	16.5m <sup>2</sup>
Max. Door Height	4.6m
Door Travel Limits	4.5 turns of door drum approx.

### Courtesy Light

Light Source	6 x Ultra Bright LEDs
Lighting Time	2.5 minutes

### Transmitter

Frequency	433MHz
Operation Range	50m (open field)
Coding Type	Fixed-code
Battery	12V (A23 Alkaline) x 1

### Features

Soft opening and closing
Safety reverse on closing and stop on opening
Digital interface for RH/LH setting, force adjustment, etc.

### Miscellaneous

Operating Temperature	-20°C ~ +50°C
Dimension (mm)	434 L x 248 W x 190H
Weight	5.4kg approx.

## TABLE OF CONTENTS

<b>Pre-Installation Notes</b>	<b>4</b>
<b>Important Notices</b>	<b>5</b>
<b>Installation Instructions</b>	<b>6</b>
<b>Connectors</b>	<b>7</b>
<b>Setting Direction of Operation</b>	<b>8</b>
<b>Setting UP-Limit</b>	<b>9</b>
<b>Setting DOWN-Limit</b>	<b>10</b>
<b>Sensitivity Auto-Learning</b>	<b>11</b>
<b>Manual Sensitivity Adjustment (For Installers Only)</b>	<b>12</b>
<b>Programming Transmitter</b>	<b>13</b>
<b>Setting Auto-Closing Timer</b>	<b>14</b>
<b>Trouble-Shooting</b>	<b>15</b>
<b>Parts Breakdown</b>	<b>16</b>
<b>Parts List</b>	<b>17</b>
<b>Warranty</b>	<b>18</b>

## PRE-INSTALLATION NOTES

The operator may be fitted to either the **RIGHT** or **LEFT** hand side of the roller door.

Check that there is sufficient side clearance to fit the operator unit as below listed:

<b>Door Type</b>	<b>Minimum side clearance</b>
"A" Series ( 25mm deep tracks )	90mm
"AA" Series (50mm deep tracks )	115mm
All doors with Windlok Tracks subject to Drum Position	140mm

Ensure there is a properly earthed mains supply socket adjacent to where the operator is to be fitted.

If the operator is being fitted at the same time as the new door installation, read these instructions in conjunction with the door installation instructions.

If the operator is being retro-fitted, make sure the door operates smoothly and is properly balanced.

N.B.: SPECIAL CARE SHOULD BE TAKEN IF RE-TENSIONING OF THE DOOR IS REQUIRED.

## IMPORTANT NOTICES

### IMPORTANT : PLEASE READ THESE INSTRUCTIONS CAREFULLY PRIOR TO COMMENCING THE INSTALLATION OF THE OPERATOR UNIT.



*This Automatic Operator has been designed to provide years of trouble-free use.*

#### READ THESE IMPORTANT SAFETY RULES FIRST

Keep the garage door balanced. Sticking or binding doors must be repaired. Garage door, door springs, brackets and their hardware are under extreme tension and can cause serious personal injury. **Do not attempt adjustment.** Call for professional garage door service .



Do not wear rings, watches or loose clothing while installing or servicing a garage door operator.

Installation and wiring must be in compliance with your local building and electrical codes. Connect the power cord only to properly earthed mains.

**The safety reverse system** test is very important. Your garage door must reverse when obstructed on closing. Failure to properly adjust the operator may result in serious personal injury from a closing garage door. Repeat the test once a month and make any needed adjustments. (See Sensitivity adjustment).



This unit should not be installed in a damp or wet space.

Push the Emergency Release handle to disengage the motor drive **ONLY** when the drive is switched OFF and, if possible, when the door is fully closed.



Do not use the sensitivity adjustments to compensate for a binding or sticking garage door. Excessive sensitivity will interfere with the proper operation of the Safety Reverse System or damage the garage door.

Disengage all existing garage door locks to avoid damage to garage door.

Install any additional Push Buttons in a location where the garage door is visible, but out of the reach of children. Do not allow children to operate push button/s or remote control/s. Serious personal injury from a closing garage door may result from misuse of the operator.

**CAUTION:** Activate operator only when the door is in full view, free of obstructions and the operator is properly adjusted. No one should enter or leave the garage while the door is in motion. Do not allow children to play near the door.

Disconnect electric power to the garage door operator before making repairs or removing covers.

**IMPORTANT:** Fix the caution label supplied to the rear of the garage door as a reminder of safe operating procedures.



**NOTE:** 1. When you disengage the unit, please move the door gently.  
2. Direction of operation (L/R) must be set correctly before operation.

**IF THERE IS ANY PROBLEM PLEASE CONTACT YOUR LOCAL SUPPLIER OF THIS OPERATOR**

## INSTALLATION INSTRUCTIONS

1. Fit anti-coning collar **TIGHT TO SHAFT** against drum at opposite end of curtain to the motor using anti-coning clip supplied in kit as shown in Fig.1.
2. Left off about pinning the curtain to the drum wheel. Ensure the curtain is pinned to the drum wheel.
3. Roll up door with at least 100mm of curtain hanging down in the tracks.
4. Ensure that the U-bolt on the end of the door opposite the end to which the operator is to be fitted is tightened securely. This U-bolt holds all the spring tension on the door once the other U-bolt is released.
5. Slide drive unit onto shaft as shown in Fig.2. Ensure the drive forks engage fully with the narrowest spoke on drum wheel.
6. For ease of installation, the sun gear can be disengaged for free rotation by pushing the Emergency Release handle downwards. To re-engage and lock the sun gear, push the handle upwards.

**Caution : Operator must be ENGAGED before proceeding further installation.**

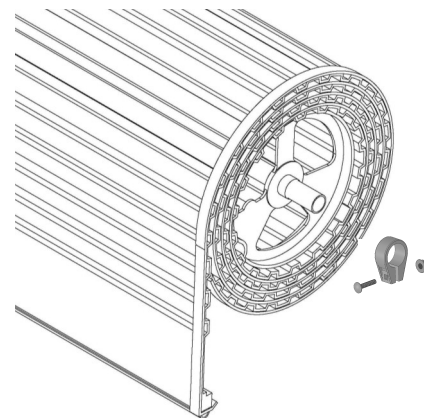

Fig.1

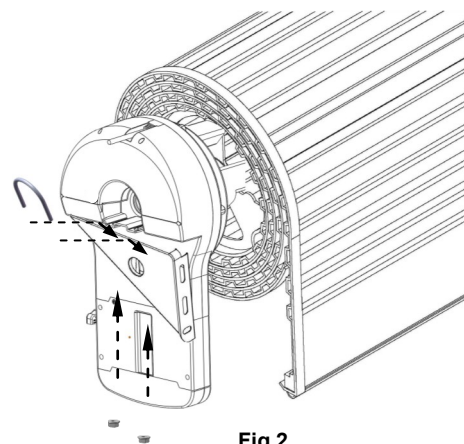
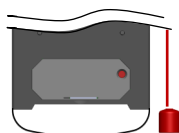
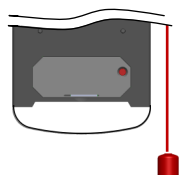

Fig.2



**Engage - Pull down the release cord firmly with 'click'  
(handle is on same level as bottom of the operator)**



**Disengage - Pull down the release cord firmly with 'click'  
(handle is below the bottom of the operator)**

Emergency Release

## I. Main Control Panel

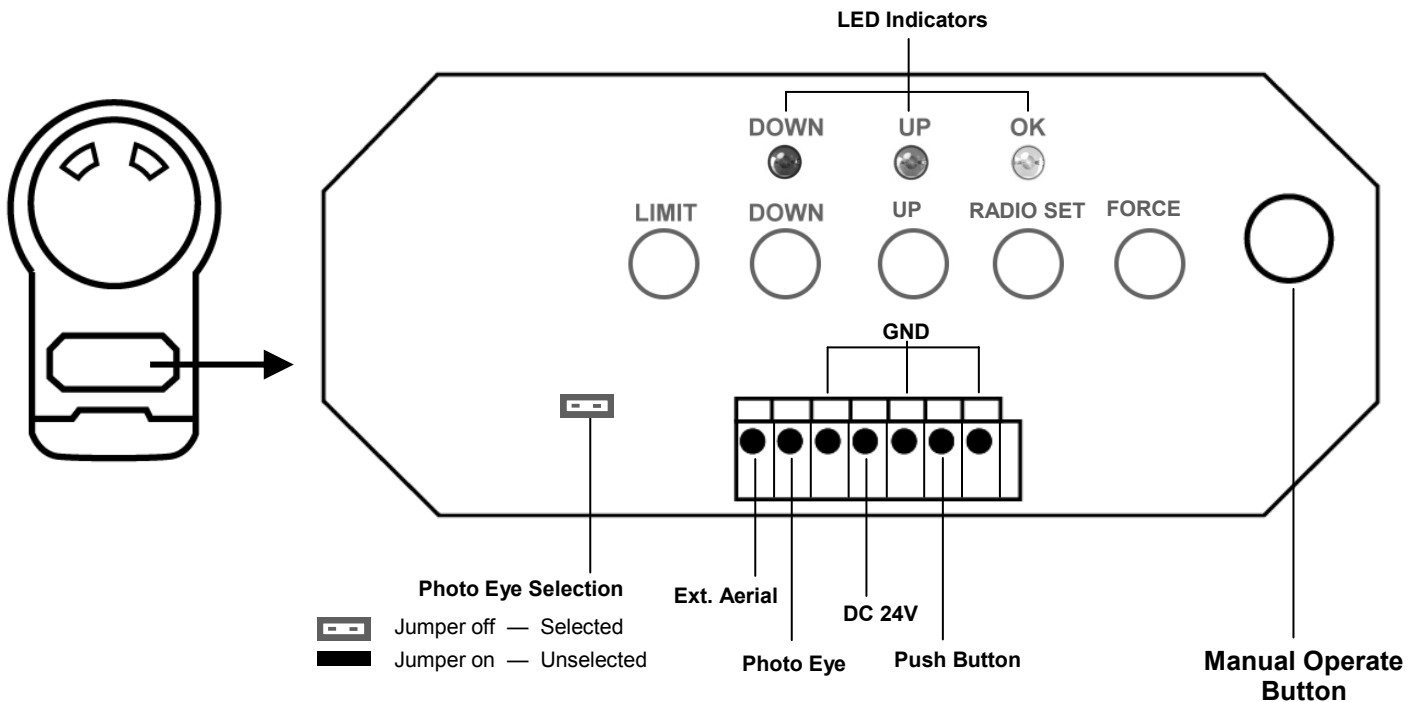

## II. Miscellaneous Control and Terminals

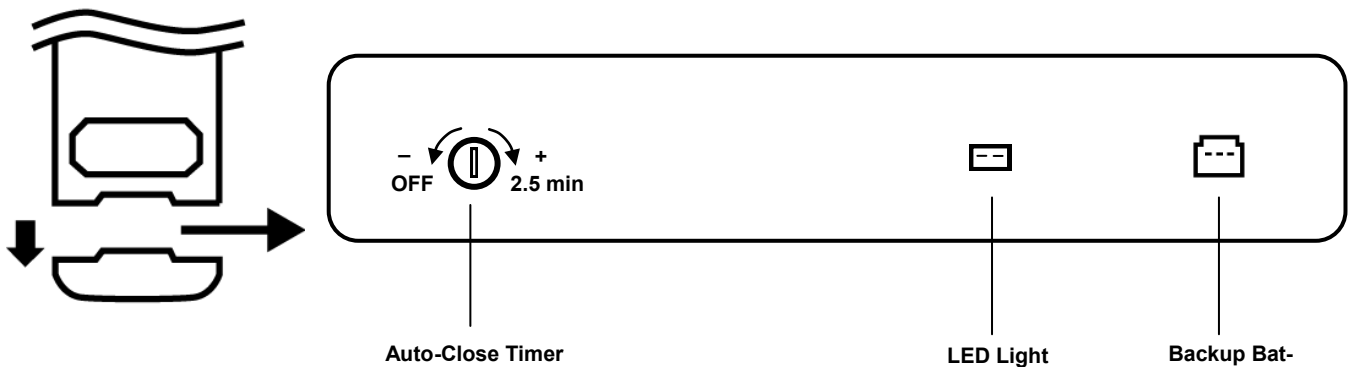

**\* Auto Close Timer function will only work when Photo Eye System is properly installed.**

To activate Auto-Close Operation	Turn the knob towards “ + ” for maximum delay time of 2.5 minutes.
To deactivate Auto-Close Operation	Turn the knob fully towards “ — ”.

**⚠ WARNING :** This operator system is equipped with an unattended operation feature when Photo Eye System is applied. The door could move unexpectedly. **NO ONE SHOULD CROSS THE PATH OF THE MOVING DOOR!**

## SETTING DIRECTION OF OPERATION

For using the operator the first time, it is necessary to set the direction of operation.

1. Connect power supply, both “UP” and “DOWN” LEDs are on.



2. Initialize the operational direction by pressing “UP” or “DOWN” button for the correct direction setting according to the illustrations below. The corresponding LED is on upon key input.

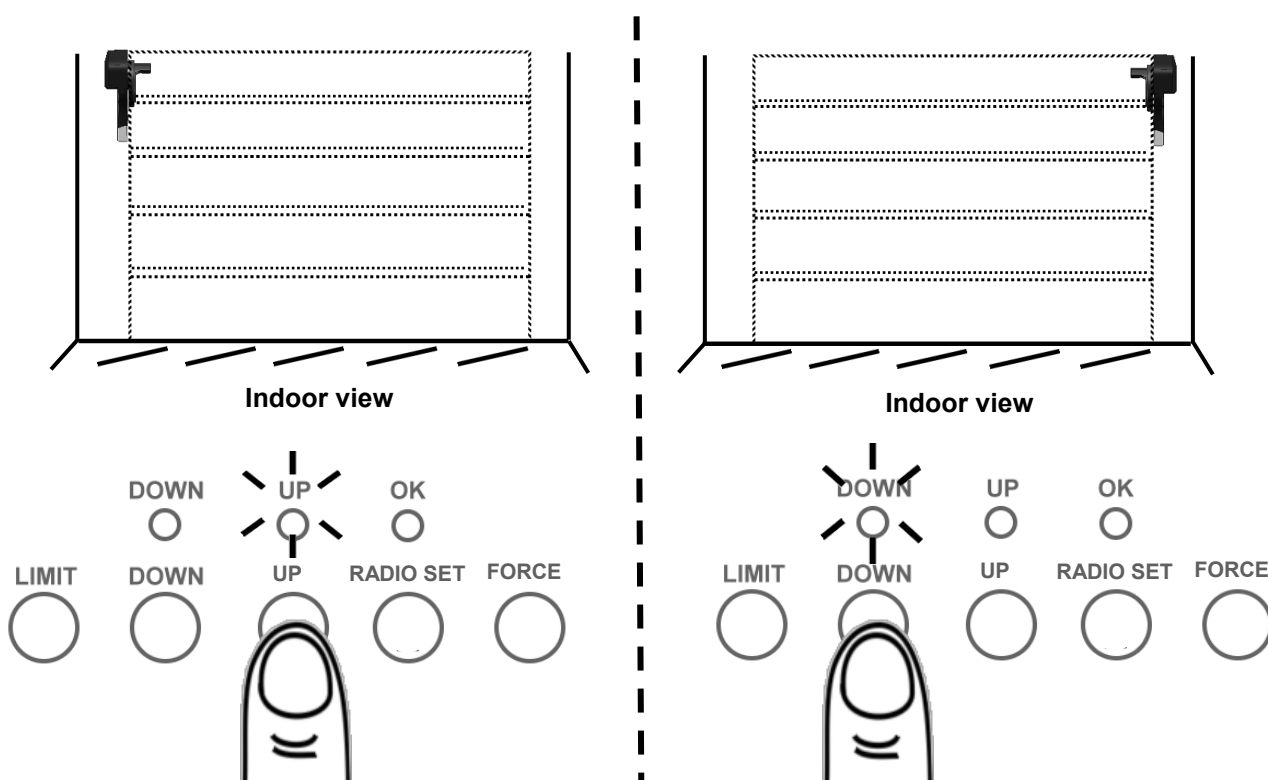

3. Press “RADIO SET” button to confirm setting. The “OK” LED is on with 2 beeps.

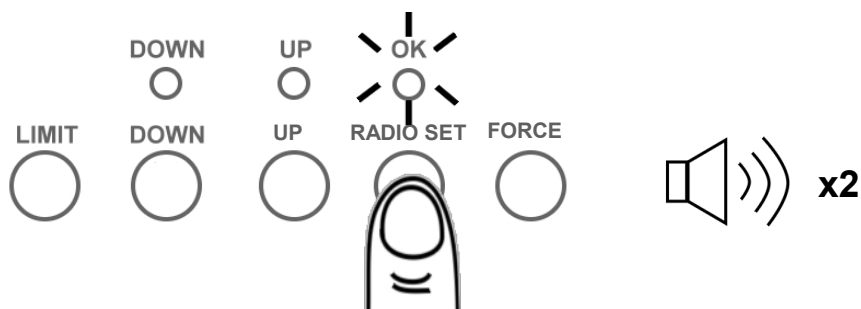

Caution : Make sure the drive unit is set for the correct side of installation!

To reset installation direction, **press the “LIMIT” button constantly** until both “UP” and “DOWN” LEDs are ON, repeat steps 2 and 3 to set the appropriate direction.



# SETTING UP LIMIT

1. Press "LIMIT" button once to enter limit-setting mode. "UP" LED is on.

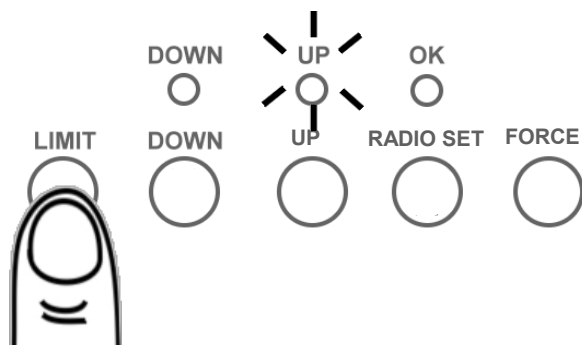

2. Press & hold the "UP" button, release the "UP" button when the door reaches the desired up limit position.

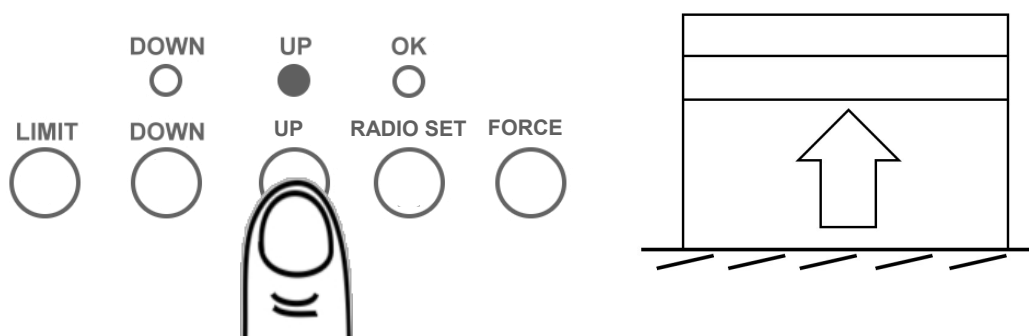

3. During limit-setting mode, press "UP" or "DOWN" to fine-tune to desired UP limit position.

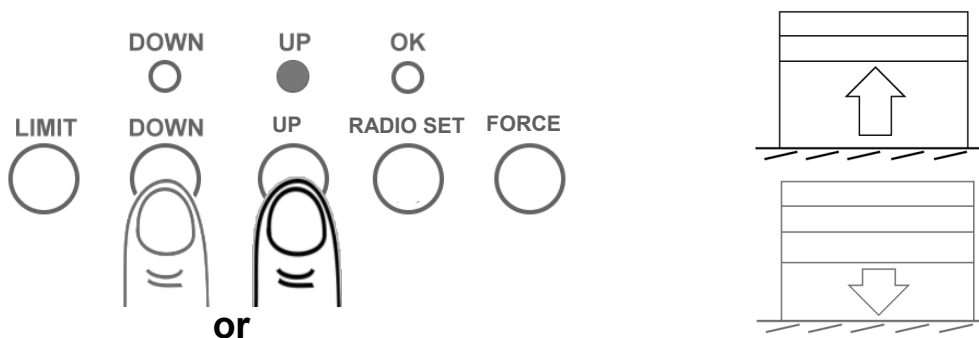

4. When the door is at the desired UP limit position, press "LIMIT" button once, "OK" LED flashes and goes out. UP limit is set.

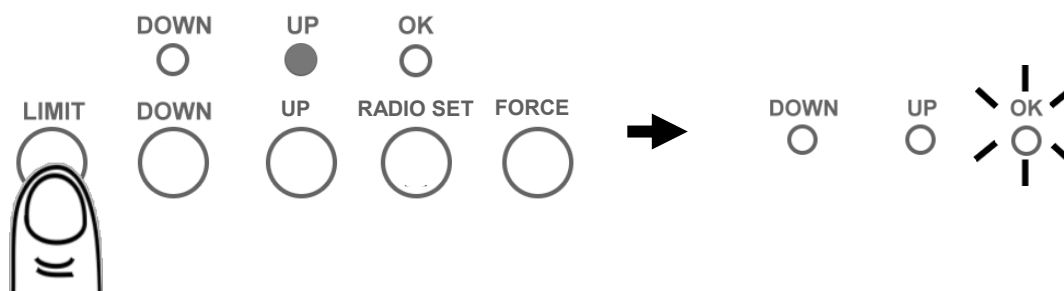

# SETTING DOWN LIMIT

1. Press "LIMIT" button twice to enter DOWN-limit setting. "DOWN" LED is on.

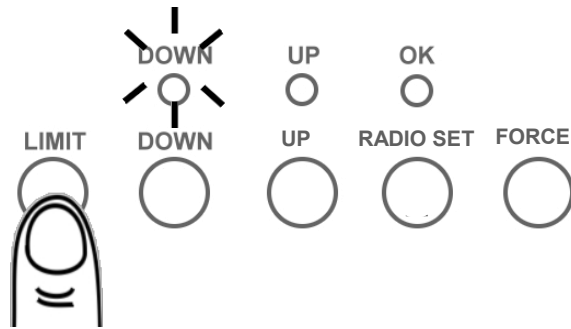

2. Press & hold the "DOWN" button, release the "DOWN" button when the door reaches the desired down limit position.



3. During limit-setting mode, press "UP" or "DOWN" to fine-tune to desired down limit position.

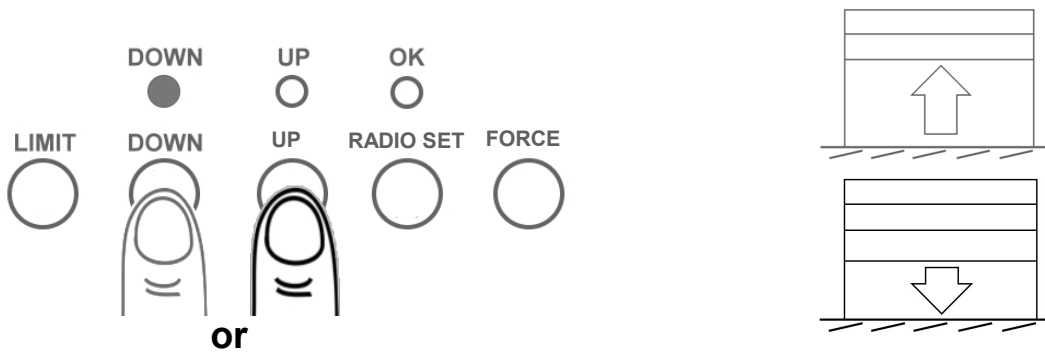

4. When the door is at the desired DOWN limit position, press "LIMIT" button once, "OK" LED flashes twice and both "UP" and "DOWN" LEDs are on. DOWN limit is set and the operator is ready for Sensitivity Auto-Learning.

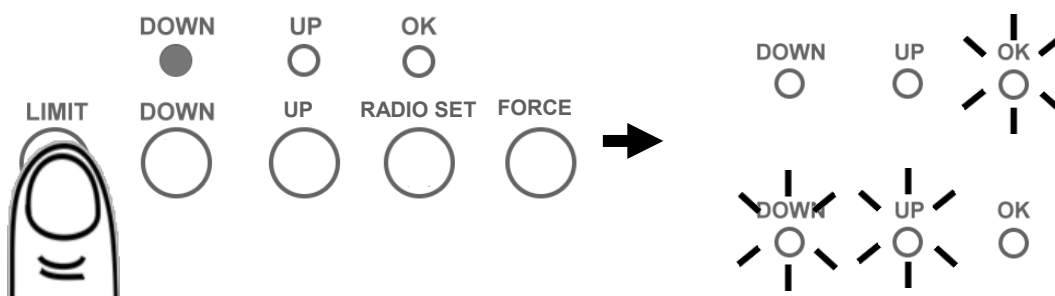

Following limit-setting, the unit is now ready to learn the sensitivity for door travel automatically. Proceed with the following steps to complete installation.

1. With both “UP” and “DOWN” LEDs are on after limit-setting, press the “FORCE” button once to enter Sensitivity Auto-Learning mode.

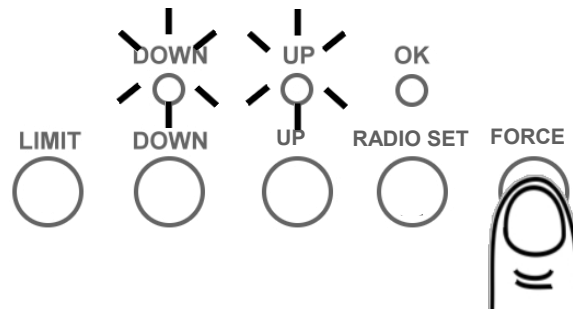

2. The door will open and stop at UP limit for 2 seconds.

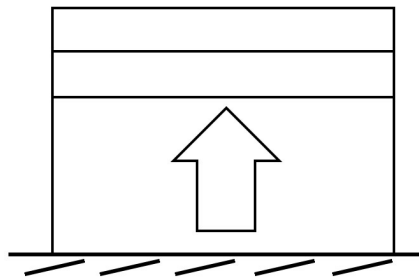

3. Door will then close and stop at down limit. The operator will beep 3 times, sensitivity is learnt automatically, acknowledging that the sensitivity has been set.

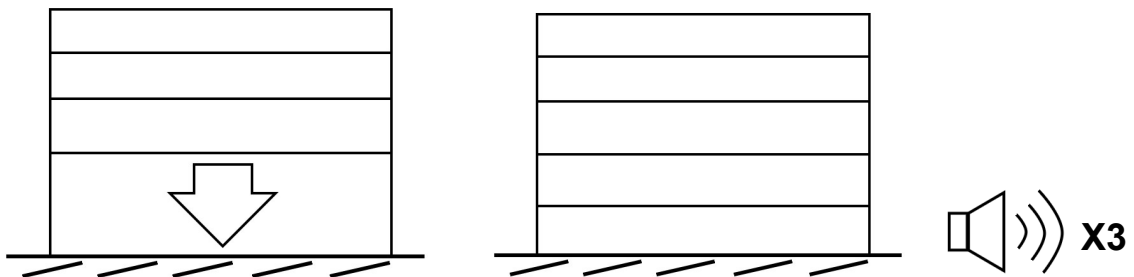

## To adjust UP Force

1. Press “FORCE” button once, “UP” LED is on. You are now in “UP Force Setting” mode.
2. To increase or decrease UP force by pressing “UP” or “DOWN” button once at a time, a beep sound indicates an increase or decrease for one increment, and 2 beeps upon upper level 8 or lower level 1 is reached. The UP Force is default at level 5.
3. To complete “UP Force” setting, press “FORCE” button. “UP” LED goes off and “OK” LED flashes once with 2 beeps. “UP Force” setting is completed.

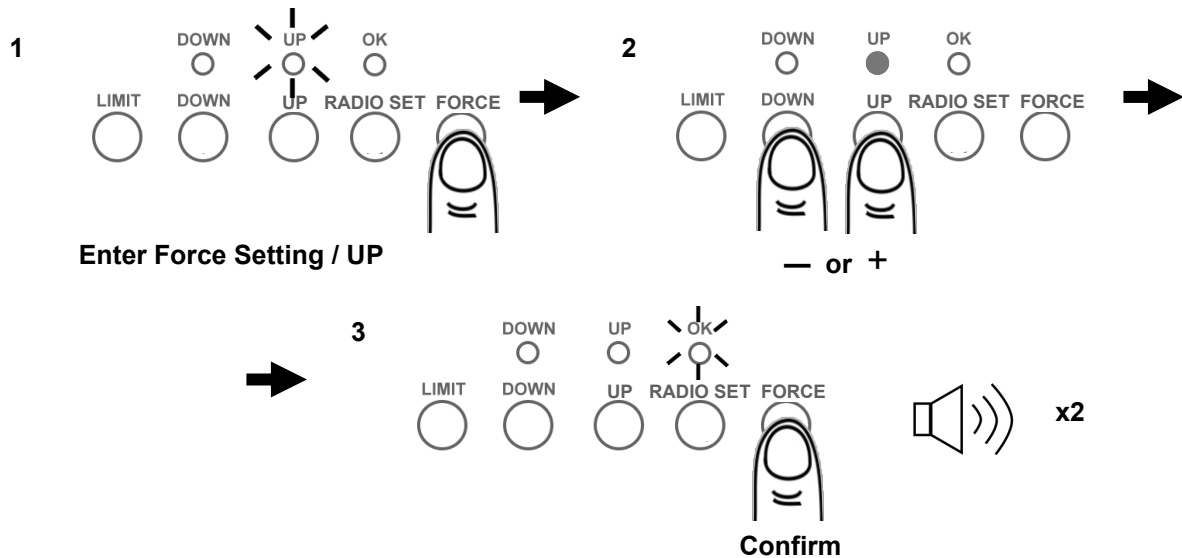

## To adjust DOWN Force

1. To adjust DOWN force, press “FORCE” button once, “UP” LED is on, then press “FORCE” button again within 5 seconds, “DOWN” LED is on, you are now in “DOWN Force Setting” mode.
2. To increase or decrease DOWN force by pressing “UP” or “DOWN” button once at a time, a beep sound indicates an increase or decrease for one increment, and 2 beeps upon upper level 8 or lower level 1 is reached. The DOWN Force is default at level 1.
3. To complete “DOWN Force” setting, press “FORCE” button. “DOWN” LED goes off and “OK” LED flashes once with 2 beeps. “DOWN Force” setting is completed.

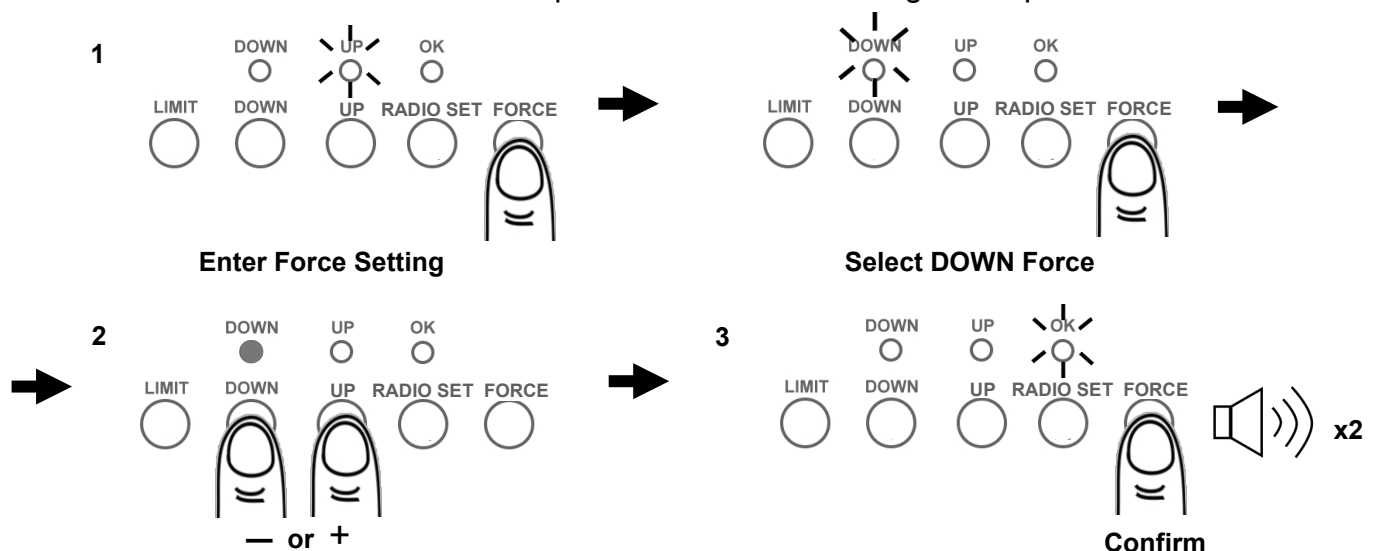

## PROGRAMMING TRANSMITTER

1. To program transmitter, press “RADIO SET” button, “OK” LED flashes twice. The unit is ready to accept a transmitter within a 30 seconds time frame.

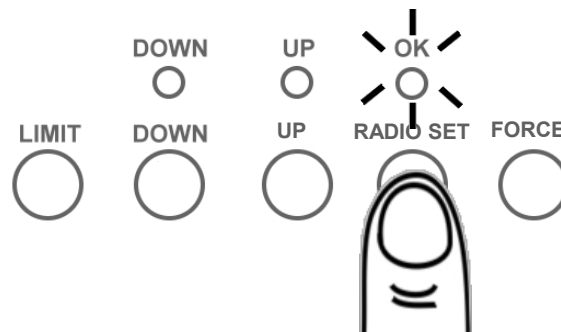

2. Press any button on the transmitter within 30 seconds.

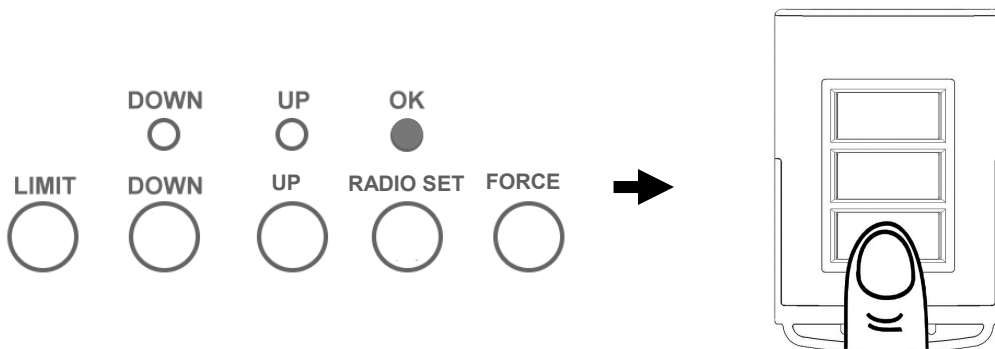

3. “OK” LED flashes once and operator beeps twice, acknowledging the transmitter is set.

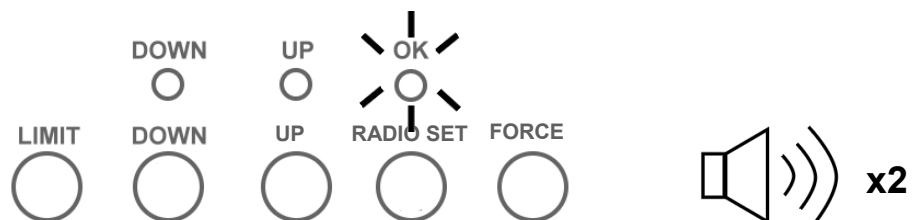

### To DELETE ALL transmitters :

Press and hold “SET” button for about 7 seconds until “OK” LED flashes and beeps twice.

## SETTING AUTO-CLOSING Operation / Courtesy Light / Buzzer Responses

**Auto-closing timer is turned off as default (the screw control is at fully “-” )**

1. Optional Photo Eye\* must be selected and properly connected and aligned to enable Auto-Closing Operation. (\* Contact your local operator supplier)
2. Turn the screw towards ‘+’ position to set to appropriate delay time (max. 2-1/2 minutes) for the door to auto-close after fully opened.

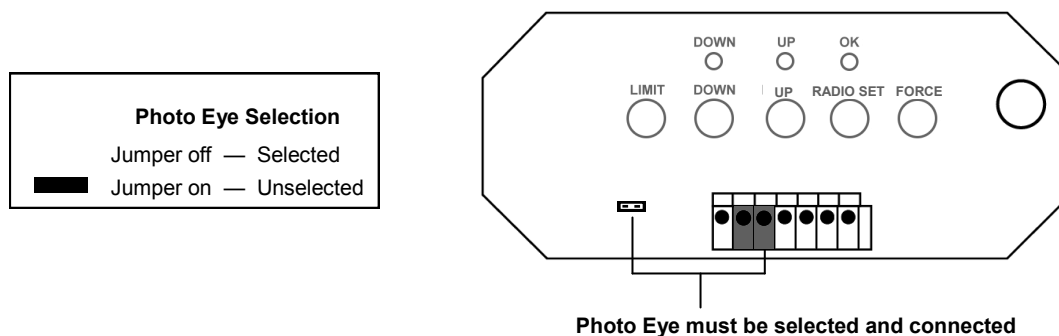

3. When the delay time is reached within the door at fully open position, the operator beeps twice and closes the door automatically.

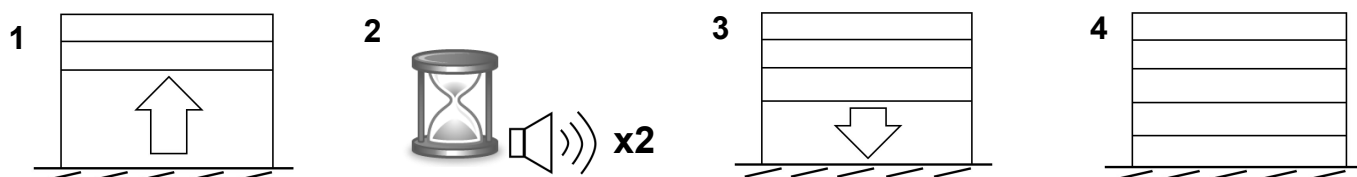

### Courtesy Light / Beeper Responses

Operation / Condition	Courtesy Light / Beeper Re-
Operator is initially plugged-in (no travel limits stored)	Flash x 5
Reconnecting power (with travel limits stored)	Flash x 3
“RADIO SET” button is pressed	Beep x 1
Upon activation	Light On for 2.5 minutes
Upon activation by remote transmitters	Beep x 1, Light On for 2.5 minutes
Remote Transmitter / Keyless Entry PIN code accepted	Beep x 2
Operator is triggered without programming	Beep x 5
Door travels with abnormal speed	Beep x 12 (1 beep / second)
Photo Eye System is obstructed during door-closing	Beep x 20 Medium Beep
The door is obstructed during travel	Beep x 25 Rapid Beep

### **DOOR WILL NOT OPERATE FROM**

#### **A) Control Panel on the Unit**

- » Check power, the courtesy light should flash upon re-connecting power.
- » IF NOT, check mains plug and fuse.
- » The Manual release is engaged.
- » Operation Direction (L/R) is set correctly.
- » Limits are correctly set, i.e. UP Limit for fully open position, DOWN Limit Switch for fully closed position.
- » Disengage and move the door manually to half-closed position, re-engage and try again.
- » Try operation with Handheld Transmitter.

#### **B) On Handheld Transmitter**

- » Check door operates correctly using the manual operate button on the unit to prove the system is okay.
- » Try re-programming Transmitter.
- » Check battery in Transmitter is correctly fitted, and the LED should illuminate upon key-press.
- » Try new battery.
- » Move aerial and try in different orientations, keeping away from steel structures and electrical cables.

### **DOOR OPERATES BUT FAILS TO FULLY OPEN OR REVERSES BEFORE CLOSING**

- » Check manual operation for correct balance, not binding. Adjust if necessary.
- » Spray silicone lubricant into tracks. Do not grease.
- » Check/adjust safety sensitivity setting.
- » Check Limits.

### **BANGS HARD ON TRACK STOPS WHEN FULLY OPEN**

- » Check UP Limit setting.
- » Adjust if necessary.

### **BANGS HARD ON GROUND AND REVERSES WHEN FULLY SHUT**

- » Check DOWN Limit setting.
- » Adjust if necessary.

### **DOOR FAILS TO TRAVEL DOWN FROM OPEN POSITION - MOTOR RUNS AND ROLLER DOOR CURTAIN BALOONS**

- » Check door curtain has smooth line of entry into tracks, as near vertical as possible.
- » Check door tension is not too great, reduce spring tension if necessary.
- » If the above does not cure the problem, then the door may require a weight bar to be fitted.

### **SHORT RANGE REMOTE CONTROL**

- » Check battery is correctly fitted in Transmitter.
- » Try new battery.
- » Move aerial and try in different orientations, keeping away from steel structures and electrical cables.

### **DOOR OPERATES BUT FAILS TO FULLY OPEN BUT REVERSES TO CLOSED POSITION**

- » Reset Limits.
- » Re-adjust Sensitivity Adjustment.

### **POWER FAILURE**

To disengage the operator

- » Pull the manual release (red handle) downwards.

To engage the operator

- » Push the manual release handle upwards.

# PARTS-BREAKDOWN

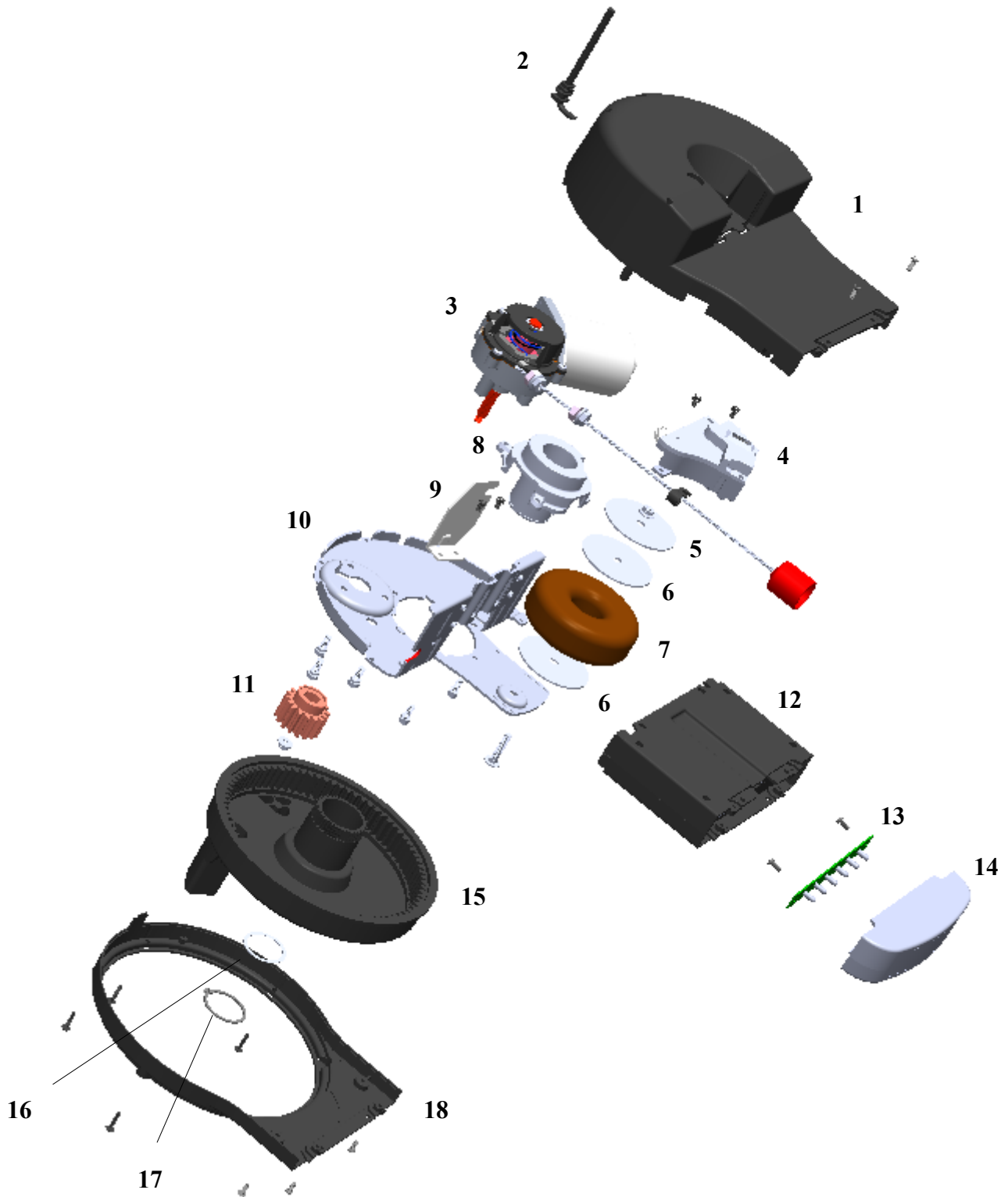



## PART List

<b>1</b>	Enclosure	<b>15</b>	Sungear Driving Wheel
<b>2</b>	Power Cord	<b>16</b>	Sungear Washer
<b>3</b>	Motor w/ Clutch	<b>17</b>	Circlip
<b>4</b>	RPM Encoder	<b>18</b>	Front Cover
<b>5</b>	Transformer Mounting Plate		
<b>6</b>	Transformer Protection		
<b>7</b>	Transformer		
<b>8</b>	Chassis Core		
<b>9</b>	Bracket		
<b>10</b>	Chassis		
<b>11</b>	Drive Gear		
<b>12</b>	Control Console		
<b>13</b>	LED Board		
<b>14</b>	LED Cover		



# WARRANTY

Guardian Garage Door Operators hereafter referred to as the Manufacturer hereby warrants:

1. Garage Door Operators to be free from defects in material and workmanship for a period of five (5) years for motors and two (2) year for Electronics and Mechanics from date of purchase, if installed by an authorized reseller, otherwise if installed by the purchaser one (1) year will apply.
2. Garage Door Operators (Commercial and Industrial Application ) to be free from defects in material and workmanship for a period of three (3) months from date of purchase.
3. Where the garage door operator has been returned to the manufacturer for Warranty repairs, all costs incurred in the return will be paid for by the purchaser. If in the opinion of the manufacturer the product is faulty, all defective parts will be replaced at no charge to the purchaser.
4. Proof of purchase must be given to the manufacturer at time of Warranty claim.
5. The manufacturer reserves the right to modify any existing or future products without incurring any obligation to incorporate such modification to products already manufactured or to which this Warranty may relate.
6. Warranty only applies if this product has been installed to the Manufacturers recommendation ( in the opinion of Guardian Garage Door Operators).
7. This Warranty does not apply to any defect, loss or damage arising or caused directly or indirectly by or as a result of :
  - (i) Any defect (including defects in component parts or accessories ) arising from or attributable to the failure to carry out normal preventative maintenance or adjustment itself.
  - (ii) To any additional damage or deterioration arising from attributable to the operation of the Operator after it is known to be defective.
8. Exclusions to Warranty Period:
  - (i) Repair or Warranty Work - three (3) month warranty
9. Not included in Warranty:
  - (i) Batteries.
  - (ii) Fuses.
  - (iii) Globes.
  - (iv) Sensitivity adjustment.
  - (v) Hand Transmitters and receiver range.
10. Note : All Warranties will be void subject to:
  - (i) Water damage and condensation.
  - (ii) Power supply black out or surge.
  - (iii) Act of God.
  - (iv) Modification or adjustment by unauthorized persons.
  - (v) Any interference from radio ( including citizen band radios or and other electronic device).
  - (vi) Preventative maintenance and regular servicing not undertaken.
  - (vii) Account not paid in full by the purchaser.
11. Subject only to the provisions of the Trade practices Act and any legislation of the State or Territory where in the doors of the Manufacturer shall have been sold or installed ( which may confer certain rights on consumers of goods and those rights by such legislation may be rendered incapable of exclusion ) this Warranty supersedes and excludes all representations, warranties and conditions whether expressed or implied by law and the Manufacturer shall have no liability or otherwise than herein provided for any loss and damage ( including consequential loss and damage, loss of use or profits ) by reasons of delay, defective or faulty materials or workmanship, negligence or any act, matter or thing done permitted or omitted to be done by the Manufacturer.

## WARRANTY

### THIS WARRANTY FORM SHOULD BE COMPLETED AT TIME OF INSTALLATION

This Warranty Form should be retained by the purchaser at all times and produced with the purchase docket by the Purchaser as proof of the purchase date.

PURCHASE'S NAME: \_\_\_\_\_

PURCHASE'S ADDRESS: \_\_\_\_\_

INSTALLED BY: \_\_\_\_\_

INSTALLER'S ADDRESS: \_\_\_\_\_

INSTALLER'S SIGNATURE: \_\_\_\_\_

DRIVE UNIT SERIAL NO: \_\_\_\_\_



